

Article number: 2310307825ESD

Description: E+G Antistatic base for levelling elements
LV.A-60-24-AS-M24x98-ESD-C

Measures

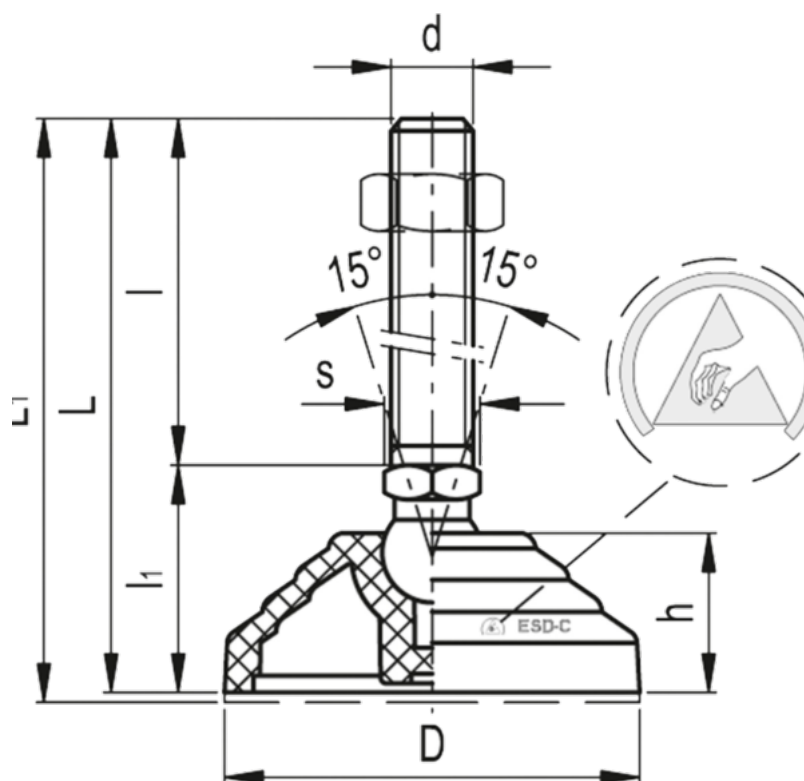

Articulation	= 24	Max load	= 18000
D	= 60	s	= 24
d	= M24	Weight in (g)	= 443
h	= 24		
l	= 98		
l1	= 43		
L	= 141		
L1	= 144		